

# Data Sheet



Article number: 12510800150500  
Description: KLEE-coil 510 800 150.500  
M5 Stainless 1.4305

## Measures

---

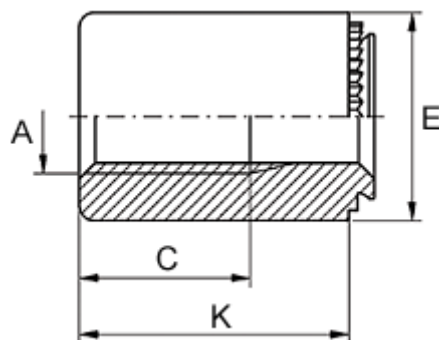

Female thread A	= M5
Height K	= 10
Min distance to edge	= 4.0
Outer diameter E	= 9
Plate thickness	= 1.1 to 1.4
Recommended bore diameter +0.05	= 6.00
Thread length	= 8.0